



AEA R44 and A440 Owner's Manual

The AEA model R44 and A440 ribbon microphones carry forward the classic tradition of the venerable 1930s RCA-44 into the 21st century. AEA's range of Big Ribbon™ mics offer the same warm, rich “long ribbon” sound of their ancestors. The R44 series even uses “new old-stock” RCA ribbon material and features a re-engineered output transformer that recaptures the sonic signature of the original RCA-44 and surpasses it in frequency response and dynamics. The R44C is a visual and sonic reproduction, taking the best of the RCA-44B and BX design, while the R44CX is the high-output version.

The A440 marries the high-output CX motor to a phantom-powered discrete-JFET impedance buffer with a very high turns-ratio transformer. The result is one of the quietest mics on the market and the quietest ribbon microphone ever. The 7 mA version has a 9 dBA noise floor and handles 136 db SPL. The custom 9 mA version has a 6 dbA noise floor and handles 132.5 db SPL. The A440 can drive very long mic cables without signal loss.

It's Only a Microphone. Why Do I Need an Owner's Manual?

Your new ribbon microphone, like all of the equipment in your recording system, is an investment in your future. It also may be the most sensitive and delicate item in your studio. Knowing how to use it properly will enable you to maintain its performance and value for decades to come — long after most of your other equipment has become obsolete.

Your Microphone Needs Good Support.

By now, you have discovered that this is a large, rather heavy microphone. In fact, it is more than 12 inches long and weighs about 8 pounds. In order to support it safely, you need a strong and sturdy microphone stand, such as the Atlas MS20 or MS25. If you want to use a boom arm, you could add an Atlas PB21X or better yet, use the Atlas SB36 studio boom stand. While there are many suitable stands from other manufacturers, conventional “musicians’ series” folding tripod-based microphone stands are not recommended because they are not robust enough to support this microphone safely. If you do need a portable stand for your mic, check out the Modular Microphone Stands page at the AEA website: http://www.ribbonmics.com/aea/modular_microphone_stands.html.

Phantom Power: Friend or Foe?

The AEA R44, like most ribbon microphones, neither needs nor wants phantom power. (More about the A440 Active Studio Ribbon Microphone in the next paragraph.) What will happen if you connect this microphone to a phantom-powered input? In a perfect world, nothing will go wrong, and the microphone will work just fine. However, if there is any defect in the integrity of the microphone cable or connection, or if the phantom power is not properly balanced, this could produce a voltage differential across the output of the microphone which can cause the ribbon to stretch or snap. The best prevention against this type of damage is to be certain that the phantom power has been turned off for *at least two minutes before you connect your microphone*. This will allow time for any stored voltage to drain from the blocking capacitors inside the mixing console.

The AEA A440, on the other hand, has internal electronics to amplify the signal and provide more output. This circuit requires conventional P48 phantom power (48 VDC, 9mA) to operate. Although a defective cable or unbalanced phantom power also can cause this microphone to perform poorly, just as they would with any condenser microphone, these will not damage the ribbon of the microphone.

Environmental Hazards

The ribbon is a thin strip of aluminum foil, 59.7 mm long, 4.7 mm wide, and 1.8-microns thick. It is tensioned lightly so that it can respond to even the most delicate high-frequency soundwaves, yet be able to withstand a sustained sound pressure level of more than 130 dB. What can damage the ribbon, however, is a strong gust of air, such as from a nearby open door, window, or air conditioning vent, the close pulse from a bass drum, the turn-on thump from a guitar or bass amplifier, moving or carrying the mic unprotected swiftly through the studio, or someone blowing into it to test if it is working.

While it is unlikely that such a blast of air will break the ribbon, it certainly can cause it to stretch. When this happens, the performance of the microphone will be degraded until the ribbon is replaced. When it is in use, avoid any situation where volumes of moving air can blow directly into the microphone. To prevent wind from damaging the ribbon, keep the mic covered with a plastic or cloth bag when it is not in use.

Covering the mic will prevent it from attracting “tramp iron” from the environment into the magnet structure. These tiny filaments of metal are all around us, resting on most flat surfaces. The strong magnetic field inside a ribbon microphone can draw these through the grille and into the gap where the ribbon is located. Eventually, enough of them can build-up to form whiskers in the gap that will rub against the ribbon, causing distortion and crackling noises. Bagging the mic whenever it is not being used will keep these out.

Gravity also can have its effects. The ribbon in your microphone is supported at its ends, but is free over its 2+ inch length. If stored horizontally over a very long period of time, the ribbon might sag due to its own weight. Microphone ribbons have no inherent life cycle. Good ribbon elements that are over 30 years old are not uncommon. The custom case provided with your new microphone provides proper support for the microphone when in storage or transit, and keeps it in the recommended vertical orientation.

Getting the Most Out of the Bidirectional Pattern

As described earlier, pressure-gradient microphones are inherently bidirectional, with equal sensitivity to the front and back of the diaphragm. In a well designed mic, the only difference is the absolute polarity of the signal. (ref. Figure-1A)

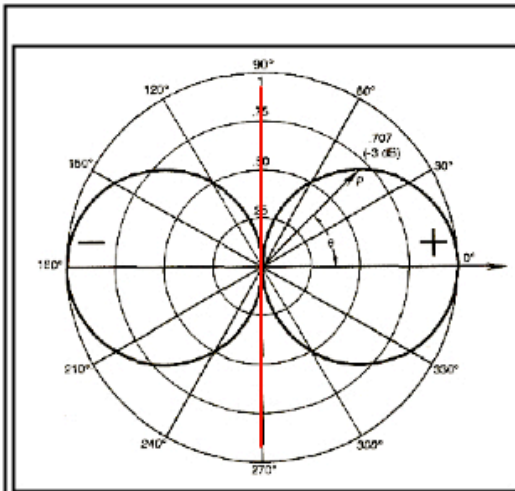

FIGURE-1A: The polar diagram of a pressure-gradient, or bidirectional, microphone. Note that the front lobe produces positive output with positive pressure arriving from the front; the rear lobe produces negative output for positive pressure coming from the back. The null-plane as shown at 90° and 270° is coincident with the plane of the ribbon.

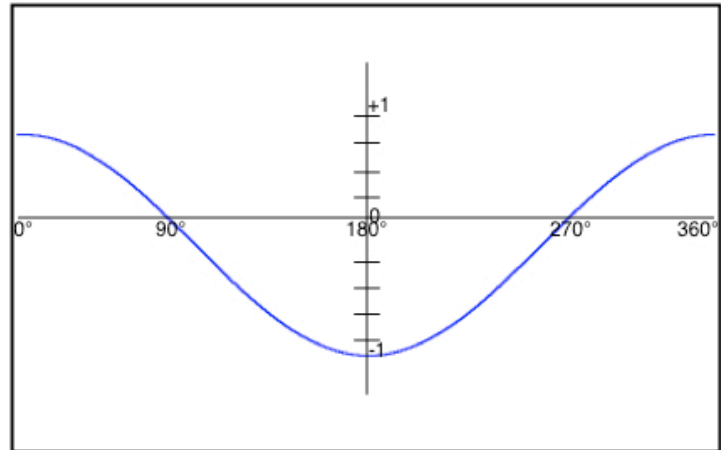

FIGURE-1B: The pressure-gradient pattern follows the cosine law: full output (+1) at 0°; negative output (-1) at 180°; decreasing output as sound arrives off-axis; nulls at 90° and 270°.

Because the polar response of a pressure-gradient microphone obeys a cosine-law, the sensitivity decreases evenly as the sound source moves away from the primary 0° (or 180°) axis, until it reaches 90° (or 270°) where the microphone has a very steep null. (ref. Figure-1B) This is the deepest null of all polar patterns — nearly -90dB in the plane of the diaphragm — with a well designed model. It is important to realize that this null plane extends both laterally and vertically with respect to the principal axis of pickup.

Most people, when using a directional microphone, just aim it at the subject, giving little thought to the overall polar response pattern. While this “point and shoot” approach might work in a simple recording or PA situation, there is much more to consider when “the going gets rough.”

Careful aiming of the “nulls” of a microphone’s pattern often can be more critical to the quality of the sound pickup than where the principal axis is pointing. Intrusive sounds, such as PA, monitor, reinforcement speakers, other nearby instruments, noisy air conditioning equipment, or other environmental noises, can be reduced significantly by proper aiming of the nulls of the microphone. By reducing these unwanted sounds, the clarity of the pickup will increase dramatically. Your new AEA ribbon microphone has a very deep null plane. Use it wisely and to your advantage.

¹ Several paragraphs and diagrams in this manual have been adapted from: *The Bidirectional Microphone: A Forgotten Patriarch* – by Ron Streicher and Wes Dooley; *Journal of the Audio Engineering Society*, Vol. 51, No. 4, pp. 211-225, 2003 April. A complete copy can be downloaded from the AEA website: www.ribbonmics.com.

Minimizing Feedback

Deep nulls mean good rejection of unwanted sounds. This can be most beneficial in sound reinforcement situations, where feedback is always threatening.

Figure-2 shows a typical concert setup, where a performer is downstage-front and a central loudspeaker cluster is directly overhead. In this situation, the loudspeaker cluster will be 90° off-axis (vertically) to the microphone. Because a cardioid microphone is only -6dB down at 90° the potential for feedback can be high. By using a bidirectional microphone, however, with the deep null plane aimed directly at the cluster, the potential for feedback can be eliminated almost completely. With the performer directly on-axis, the rear lobe will be aimed out into the audience, which is so much farther away that the inverse square law will prevent their pickup by the microphone.

Similarly, if side-fill stage monitors are used, because these also are at $\pm 90^\circ$ to the performer, a bidirectional microphone again will provide optimum rejection of these for the prevention of feedback.

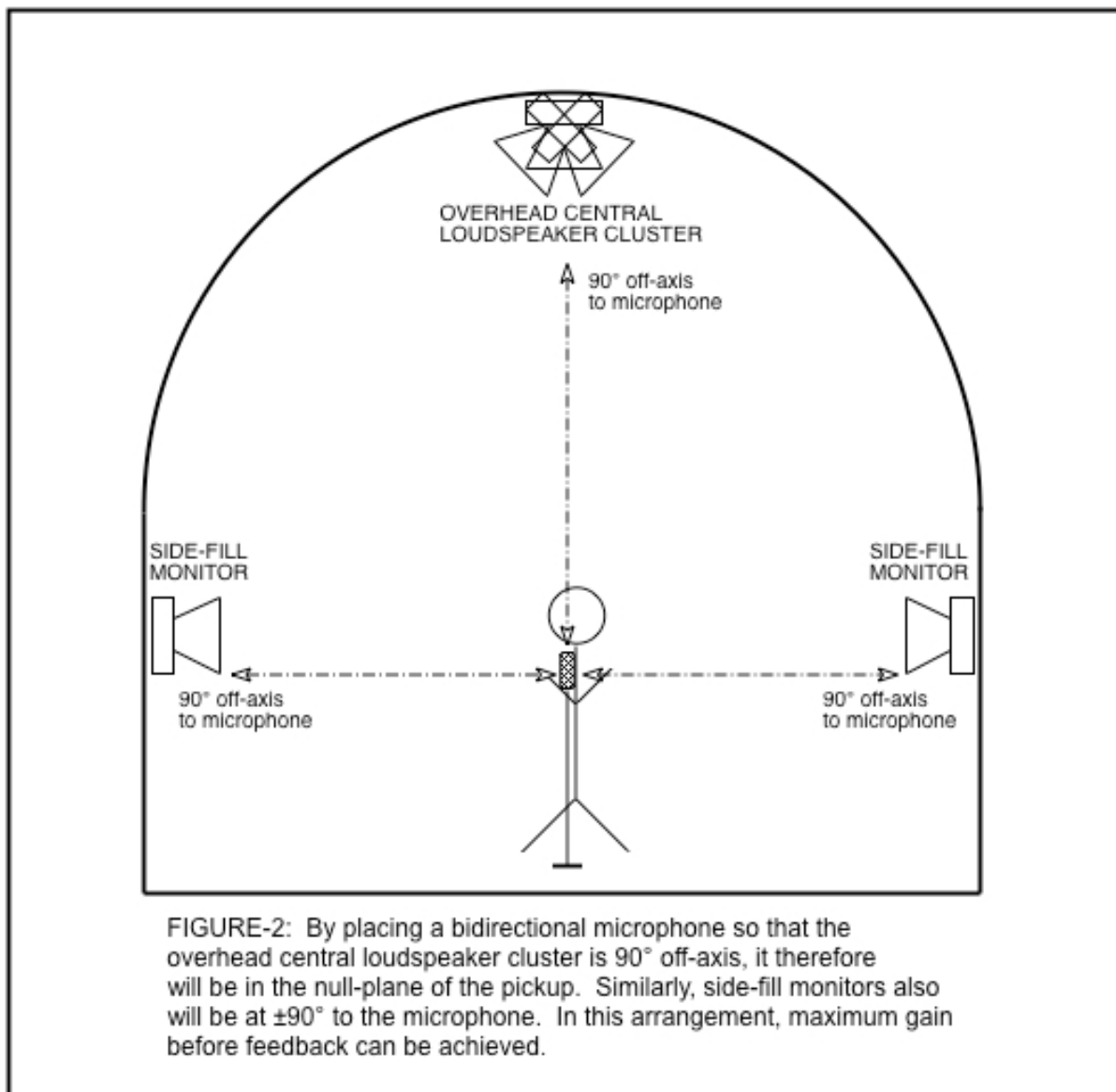

Reducing Environmental Noise

Out of doors or in large interior spaces such as soundstages, factories, or warehouses, environmental or general background noise tends to approach a microphone along the plane of the horizon if its source is either reasonably distant or random in nature. Because this soundwave will, in effect, produce equal pressure on both sides of the diaphragm of a vertically-oriented bidirectional microphone (i.e. the diaphragm is horizontal) this noise will self-cancel and sound sources that are closer and more directly on-axis will prevail. Jim Tannenbaum, a very active film dialog mixer in Hollywood, explained at an AES Workshop how he uses this to good effect in recording actors in a noisy environment: By placing a bidirectional microphone just below the camera's view and orienting its pattern vertically, the actor's voice is picked-up by the front lobe while the rear lobe is aimed at his feet — which presumably are not making any noise at all. (ref. Figure-3) The result is that the environmental noise pickup is significantly less than the direct sound of the talent, producing clean and useable dialog.

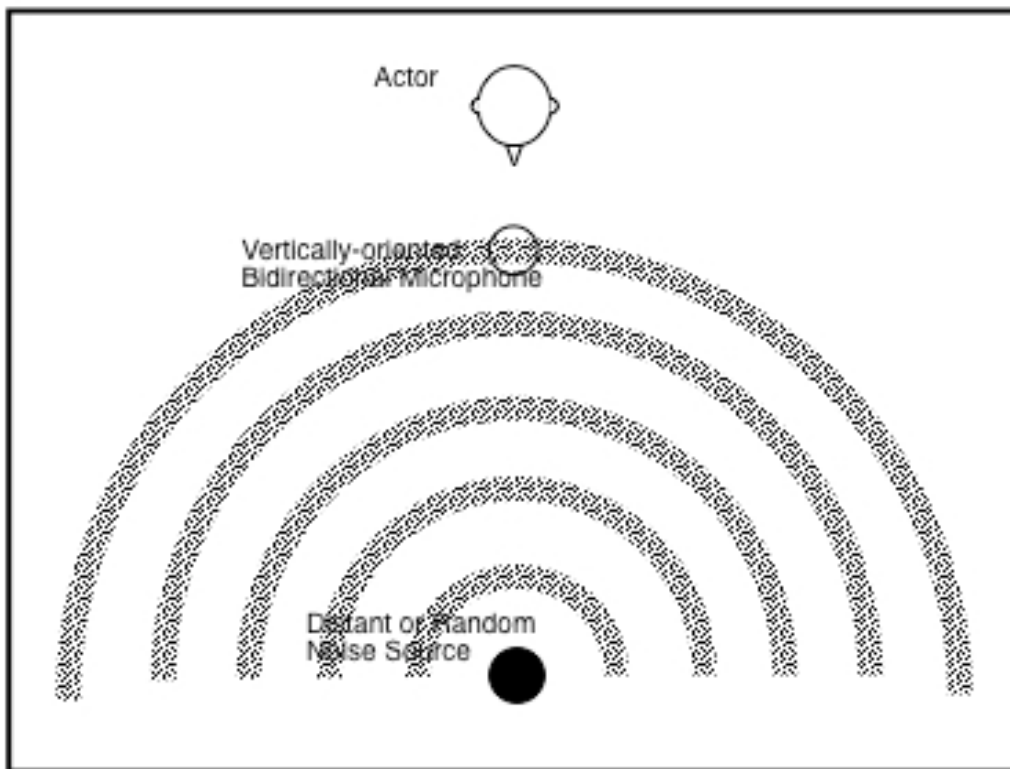

FIGURE-3: The soundwave from a distant or random noise source approaches the microphone and actor as a horizontal plane wave. If the microphone is a vertically-oriented bidirectional, the noise will be reduced significantly relative to the closer, on-axis actor's voice.

Minimizing Pickup of Nearby Instruments

A significant and ever-present problem in contemporary studio recording is minimizing leakage from nearby instruments into the various microphones. While gobos (portable isolation walls) can be effective in isolating performers from each other, they often introduce their own set of problems. To be effective, gobos are usually very bulky and occupy valuable floor space. They also inhibit the ability of the musicians to hear each other, thus requiring complex and often cumbersome headphone monitor mixes for the musicians.

One solution to this problem is to use bidirectional microphones and arrange the musicians so that they are at right-angles to each other, thus placing nearby musicians in the null of their neighbor's microphone, and vice versa. Although this won't entirely eliminate the need for gobos, it will reduce the number you need. As a result, the studio can be less crowded, and because the musicians now will be better able to hear each other directly, the need for numerous monitor headphones also can be reduced. Another common problem in both recording and sound reinforcement situations occurs when a singer is also playing an instrument, such as guitar or piano. The need to provide good isolation between the singer's voice and the instrument usually leads to the use of separate microphones for each, but this can lead to problems of balance and phase interference between the microphones. In both of these situations, the use of a single bidirectional microphone can provide the solution.

Vocal ensembles, such as duets, trios, and quartets, also can use these microphones to good advantage by grouping around the mic and balancing their voices to achieve a proper natural blend. This can eliminate the need to rely on a mixing engineer to make them sound right: the musicians do it themselves!

For Announcers, Dialog, and Radio Plays

Ever since the "golden days of radio" in the 1930s and '40s actors have appreciated working with bidirectional microphones such as the RCA-44. Not only does this have an unsurpassed quality with the human voice, the two-sided pickup helped to create the art of radio acting because it allowed the actors to work on either side of the microphone so they were able to face and act to and with each other. Coming into a scene meant doing little more than starting with one's head turned slightly away from the mic and then turning back toward the mic as dialog began. If a more distant approach was required, beginning the scene just a step or two back and then moving towards the mic would produce this effect. Coming in from an even greater distance could be accomplished by starting the dialog from the side of the microphone and then moving around to be on-axis. Throughout all of this, the script could be held directly to the side of the microphone allowing the actors to read, yet minimizing the sound of the pages rustling as they were changed.

Proximity Effect

Proximity effect or "bass tip-up" is a characteristic of all directional microphones, but none exhibits more than the single-diaphragm velocity microphone. In fact, it is the pressure-gradient component in all directional microphones that renders them susceptible to proximity effect. Pressure response microphones, on the other hand, are not subject to it and retain relatively flat low frequency response at any distance.

Although this is generally considered the result of working at a very close distance to the microphone, the AEA R44 and A440 exhibit measurable proximity effect at distances closer than six feet. (ref. Figure-4) This rising low-frequency response at closer working distances can be used to good effect, par-

ticularly with male voices to give them an almost “superhuman” richness and depth. Like most things in audio, however, the potential tradeoff is reduced articulation or clarity that can result from excessive bass response or “boominess.” Proximity effect should be treated like any other form of equalization and, as such, used with care and moderation.

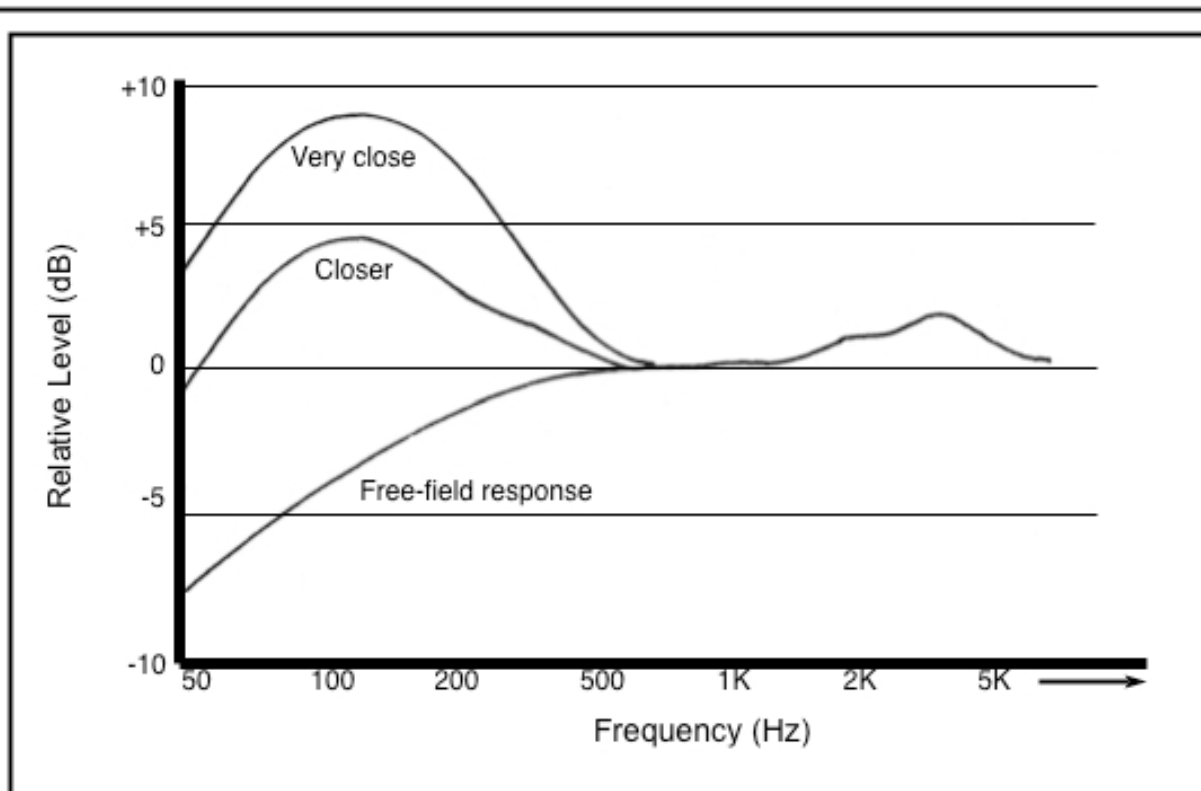

FIGURE-4: Proximity Effect or "Bass Tip-up" The low-frequency response of all directional microphones increases as the working distance decreases. These generic curves represent the LF response variations due to proximity effect as the microphone is moved closer and closer to the soundsource.

THE AEA R44 BIG RIBBON™ MICROPHONE

Design Concept:

The AEA R44 is an exacting reproduction of the original RCA-44B/BX velocity microphone originally produced in the mid-1930s. After producing replacement parts and repairing these venerable classics for more than a decade, AEA decided to reissue a new version of the microphone — one that would be as close as possible to the original in every respect.

After consulting with many engineers, it was decided that the earlier versions, built from the late 1930s to the mid-1940s, were the ones most prized by both users and collectors alike. Under the guidance of a few of the engineers retired from the RCA production team, AEA began to build painstakingly accurate, hand-assembled reproductions. Other than the magnets, even the parts of the AEA R44C and R44CX are interchangeable with the original RCA microphones. The only caveat was magnet technology. AEA microphones utilize Neodymium instead of Alnico magnets to provide increased output. The R44CX is about 5 dB “hotter” than an original RCA-44 and the AEA R44C.

Features:

The R44 design runs contrary to all current ribbon microphone manufacturing. It is large and heavy while other microphones are smaller and lighter. The internal ribbon element is by far the longest, and its resonance tuning the lowest of today’s ribbon microphones. Because the ribbon is tuned to a very low resonant frequency, it exhibits none of the upper midrange high-Q resonance peaks common to large diaphragm condensers. This ribbon design delivers extremely fast and accurate transients. Such a lightly-tensioned, ultra low mass ribbon is almost perfectly damped by the air itself. This approach had been out of production for over 50 years despite remaining in continuous studio use. It is different, and its sound is unique.

Characteristics of these microphones are their “warm” and “rich” sound when used to pickup vocals. It is easy to hear why the original RCA44 was the microphone of choice for most of the singers throughout the “golden age” of the big bands: Bing Crosby, Frank Sinatra, Ella Fitzgerald, Billy Holliday, and many others. Similarly, instrumentals benefit from the “ribbon sound” that put Glenn Miller, Benny Goodman, Tommy Dorsey, Harry James, Stan Kenton, and so many others on the air.

The single ribbon diaphragm provides an almost perfect figure-of-eight polar pattern, with even and accurate frequency response as the sound source approaches from off-axis. The null at $\pm 90^\circ$ is almost -90dB down relative to the front or rear of the microphone, providing it excellent rejection of unwanted environmental noise.

The Big Ribbon™ design provides very low self-noise and enables the microphone to handle high SPL with wide dynamic range — maximum 140 dB/SPL above 200 Hz.

Because the AEA R44C and R44CX microphones neither need nor want phantom power, they can be used with any high-gain, low-noise preamplifier. Check out the AEA TRP and RP48Q on the AEA website: www.ribbonmics.com.

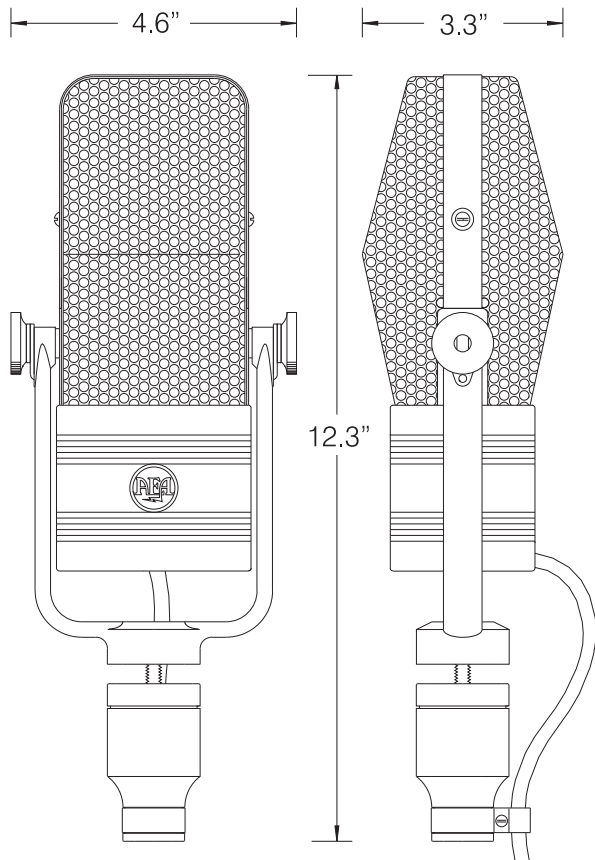

Weight: 7 pounds, 9 ounces in storage case
 Length: 12.25 inches, Width: 4.62, Depth: 3.25"

Specifications:

Operating Principle: Velocity microphone

- Frequency Response: 20 Hz to 20 kHz
- Maximum SPL: 165 + dB SPL above 1 kHz for 1% third harmonic
- Output Sensitivity: 2.25 mV / Pa into unloaded circuit
- Output Impedance: 270 Ω broadband
- Recommended Load: 1.2 k Ω or greater
- Powering: Not required or recommended
- Polarity: Pin 2 high for positive pressure on the front of the microphone.
- Connector: XLR-3M wired to a 3 meter captive cable

Off Axis Response:

- Polar Pattern: Native bi-directional pattern
- Horizontal: Level changes with angle, frequency response is consistent, -90 dB null at 90° / 270°
- Vertical: Level changes with angle, reduced HF response above and below 0° / 180° axis, null at 90° / 270°

Transducer element

- Ribbon Thickness: 1.8 μ (0.000018 m) of pure aluminum
- Ribbon Width: 4.7 mm
- Ribbon Length: 59.7 mm

Accessories:

- Included: Custom storage / shipping case, stand adapter, manual
- Optional: Any length cable, inquire for price and delivery.
- Custom transformer case laser engraved with your art or logo

Limited Warranty:

- Three years parts and labor, shipping not included.

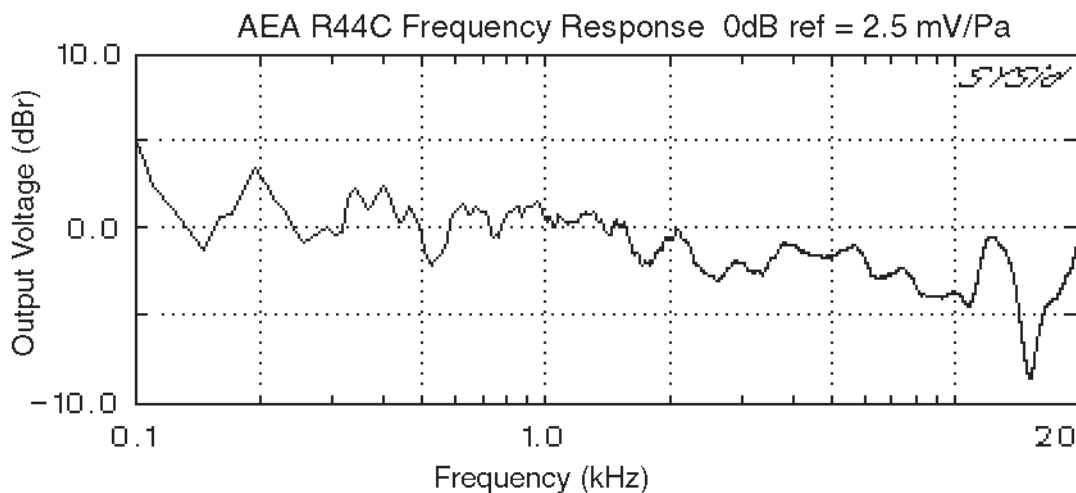

Displayed range from 100 Hz up due to measurement room size limitations.

THE AEA A440 ACTIVE STUDIO MICROPHONE

Design Concept:

The AEA A440 is based on the model R44CX Big Ribbon™ microphone, but uses a transformer with a higher turns ratio and adds an internal phantom powered JFET low noise buffer amplifier. These increase the output level by 20 dB and reduce the self-noise, making the A440 ideally suited for the most critical recording applications.

Features:

The A440 shares many features and sonic qualities of its non-powered cousins, but has a character of its own. It is often described as being more “open and transparent” than any other ribbon microphone. With a high sensitivity of -33.5 dBV/Pascal and a low output impedance of 92 Ohms, it can be used where other ribbon mics cannot — anywhere that low-noise, high immunity to RF or EMI noise fields, and/or long cable runs are required.

The A440 is one of the quietest mics around and is the quietest ribbon microphone. At 7 mA current draw, it has a 9 dBA noise floor and handles 136 db SPL. A custom 9 mA version has a 6 dbA noise floor and handles 132.5 db SPL. Such wide dynamic range is equal to the best studio condenser mics.

Specifications:

Operating Principle: Velocity microphone

Frequency Response: 20 Hz to 20 kHz

Maximum SPL: 136 dB SPL with a 1 kΩ load for < 1% THD

Output Sensitivity: 30 mV (-33.5 dBV)/Pa, 1 Pa = 94 dB SPL

Output Impedance: 92 Ω broadband

Recommended Load: 1 kΩ or greater

Powering: P48 phantom power, 7 mA

Polarity: Pin 2 high for positive pressure on the front of the microphone.

Connector: XLR-3M wired to a 3 meter Accusound cable

Off Axis Response: (level changes with angle, frequency response is consistent)

Polar Pattern: Native figure-eight bi-directional pattern

Horizontal: Level changes with angle, frequency response is consistent, null at right angles to major axis 90°/270°

Vertical: Level changes with angle, reduced HF response above and below 0°/180° axis, null at right angles to major axis 90°/270°

Transducer element

Ribbon Thickness: 1.8 μ (0.0000018 m) of pure aluminum

Ribbon Width: 4.7 mm

Ribbon Length: 59.7 mm

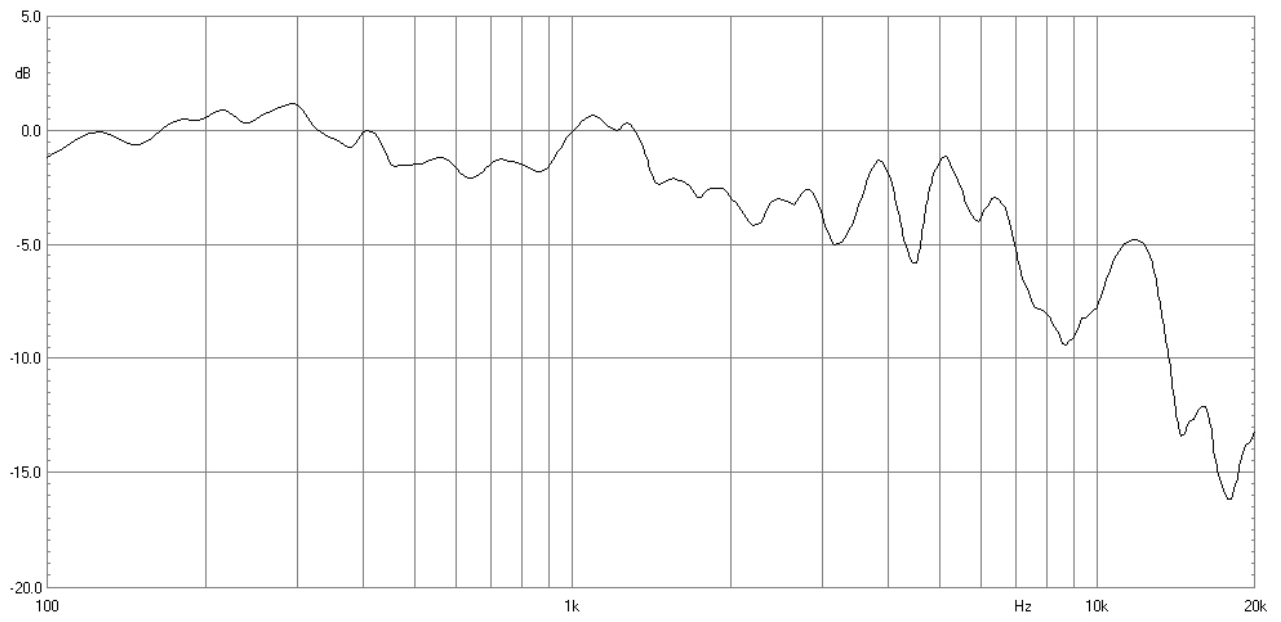

Displayed range from 100 Hz up due to measurement room size limitations.

WARRANTY

Audio Engineering Associates warrants the AEA R44C, R44CX, and A440 against defects in materials or workmanship for three (3) years from the date of purchase. Ribbons damaged by phantom power or excessive air turbulence are not covered by the warranty. For repairs to units exhibiting ribbon damage, abnormal physical abuse, or that are out-of-warranty, AEA will provide a repair estimate and will not proceed with service without the customer's authorization. Shipping and insurance costs both ways are the responsibility of the customer. Please contact AEA prior to sending the unit in for repair. A form for requesting service may be found at www.ribbonmics.com.

No user serviceable or adjustable parts inside. Do not open the case.

Audio Engineering Associates
1029 North Allen Avenue, Pasadena, CA 91104
Phone: +1(626) 798-9128 Fax: +1(626) 798-2378
URL: www.ribbonmics.com e-mail: stereoms@aol.com

References and Recommended Reading:

BASIC STEREO MICROPHONE PERSPECTIVES - A REVIEW, first published in the AES Journal, vol. 33, no. 7/8, pp. 548-586, 1985 July/August; republished in the STEREOPHONIC TECHNIQUES ANTHOLOGY, pp. 297-305

THE BIDIRECTIONAL MICROPHONE: A FORGOTTEN PATRIARCH, was first presented at the 113th AES Convention in Los Angeles, 2002 October, Preprint no. 5646; it is scheduled for publication in the AES Journal in the 2003 April issue (vol. 51, no. 4)

THE NEW STEREO SOUNDBOOK, third edition, by Ron Streicher and F. Alton Everest, published by Audio Engineering Associates, 1998; www.stereosoundbook.com.

RIBBON MICROPHONE ESSAYS by Wes Dooley, Ron Streicher and Philip Merrill published by Audio Engineering Associates, June 2003; www.wesdooley.com.

Appendix 1

1. THE PHYSICS OF RIBBON PRESSURE-GRADIENT MICROPHONES

All microphones respond to the minute changes in air pressure as a soundwave arrives at their diaphragm. As transducers, they convert this acoustical energy into electrical energy that can be amplified and recorded or broadcast. Some microphones respond only to variations in the absolute pressure — the compressions and rarefactions that travel through the air as a soundwave — as they arrive the surface of the diaphragm. These are called pressure-response pickups and have an omnidirectional polar pattern because absolute pressure is not dependent on the direction of approach. (ref. Figure-5)

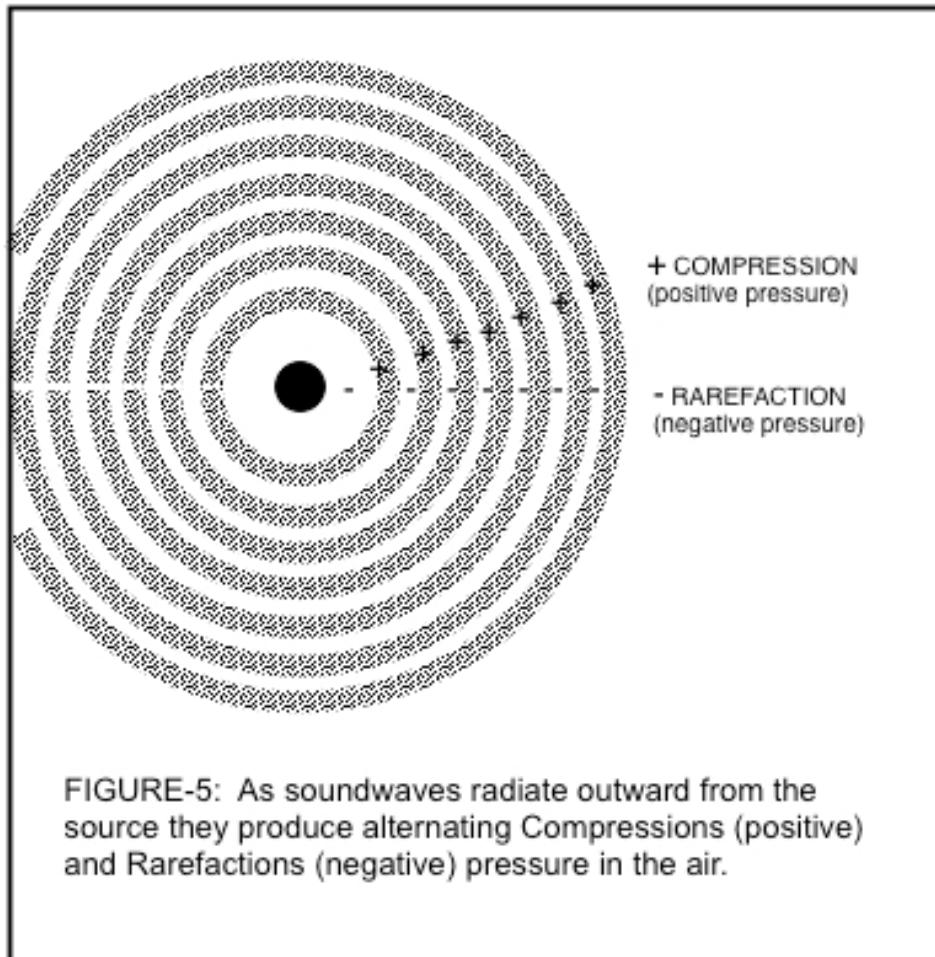

The first microphones were developed by the infant telephone industry in the late 19th Century. These were intended for close-talking and were omnidirectional because there was little need for a more directional polar response pattern.

The Physics of the Bidirectional Microphone:

With the rapid growth of the broadcast and talking-picture industries in the 1920s and early 1930s, microphones were needed that could be kept out of the camera's view yet discriminate against extraneous studio or environmental sounds and favor the talent that was in front of and more distant from them.

The first directional microphones responded to the difference in pressure between the front and back of the diaphragm as the soundwave passed by. These were termed pressure-gradient microphones and exhibited a figure-of-eight polar pattern. The diaphragm in these early microphones was a very thin aluminum ribbon that was exposed on both sides; as the soundwave moved past it created a very slight but nonetheless distinct difference in the air pressure on either side of the ribbon. This ribbon was suspended in a magnetic field and thus generated a small electric current in direct response to its movement. (ref. Figures 6A and 6B) The term velocity microphone also is commonly applied to ribbon microphones because the current in the ribbon is directly proportional to the velocity of its motion in the magnetic field.

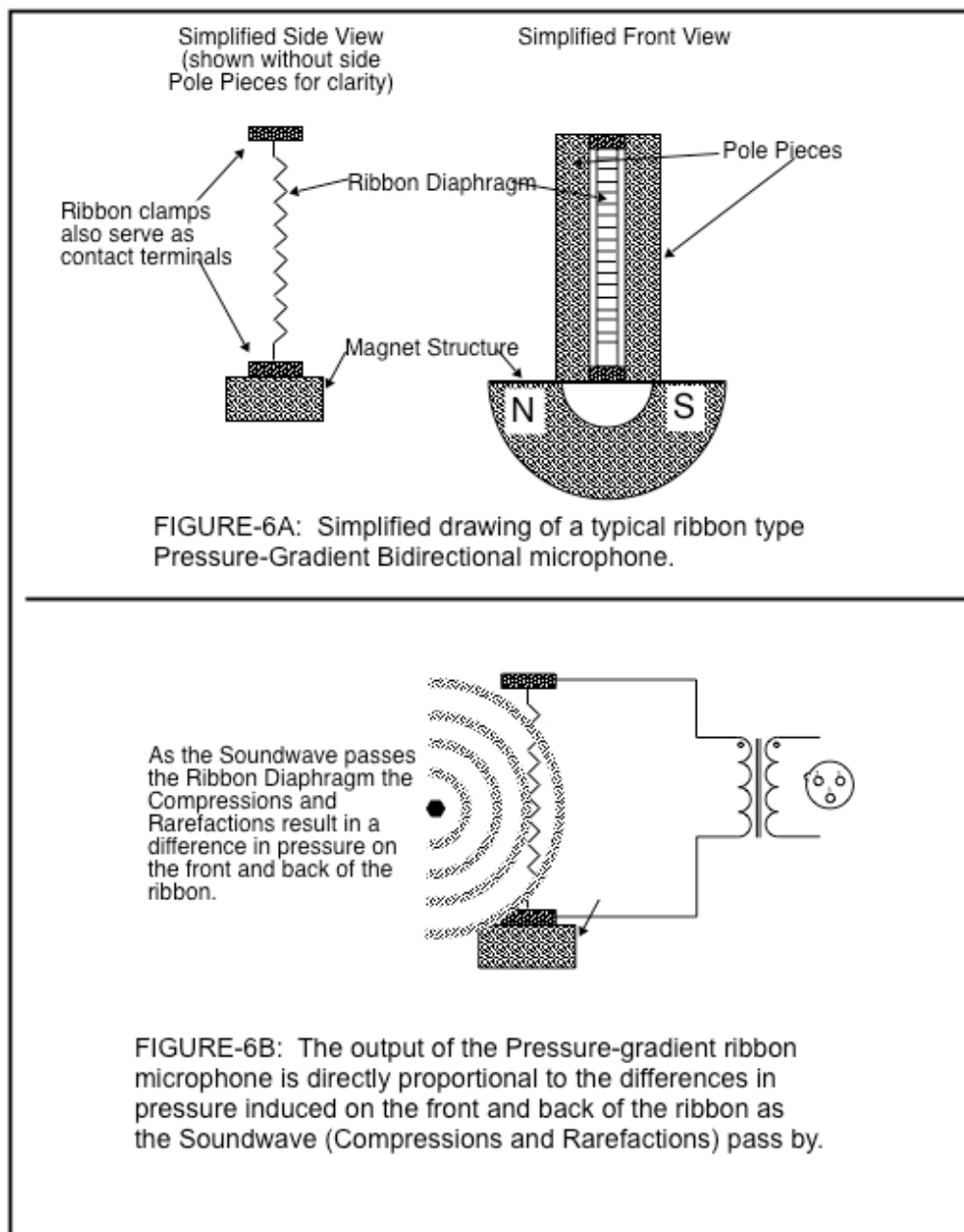

Because these were dipoles, if a soundwave approached the diaphragm directly from either the front or back, the ribbon would move equally. The only difference was the absolute polarity of the electrical output: sounds arriving from the back produce polarity opposite to those arriving from the front. (ref. Figure 7A and 7B)

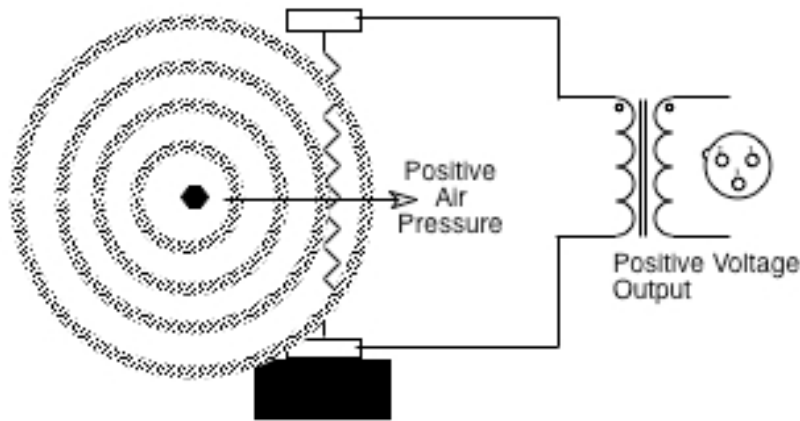

FIGURE-7A: As the Soundwave approaches from the front of the diaphragm, positive pressure produces a **POSITIVE** voltage at the output of the microphone.

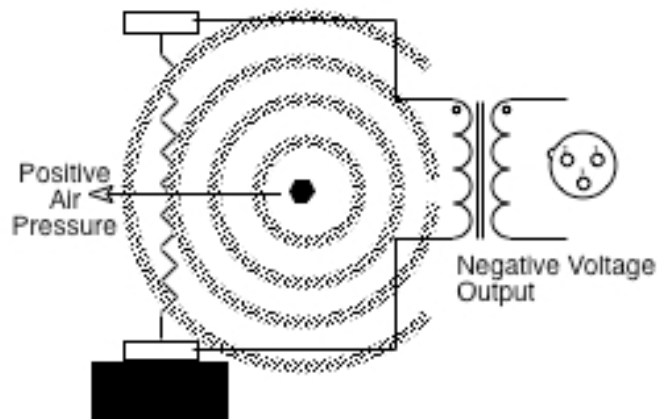
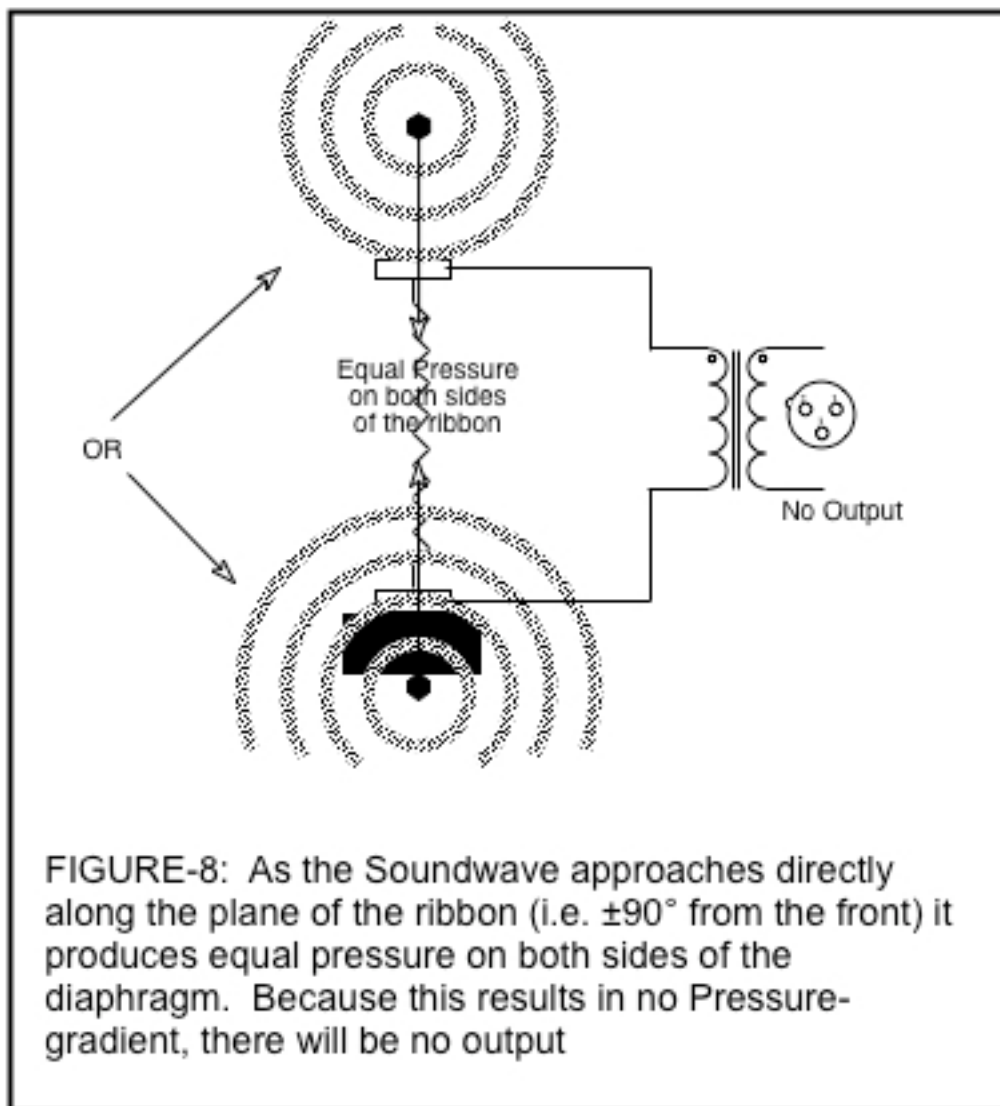

FIGURE-7B: As the Soundwave approaches from the back of the diaphragm, positive pressure produces a **NEGATIVE** voltage at the output of the microphone.

The significant operational difference between the bidirectional and omnidirectional microphone is that while the omni responds with equal sensitivity to sounds arriving from any and all directions, with a properly designed single-diaphragm bidirectional microphone, a response null of almost -90dB will occur at precisely $\pm 90^\circ$ from the principal pickup axis. Figure-8 shows that this null exists both vertically and horizontally because a soundwave approaching the microphone along the plane of the diaphragm will produce equal pressure on both sides of the diaphragm. If there is no difference in pressure on the

front and back of the diaphragm, there will be no output signal. Because this null plane affects both sides of the diaphragm equally, the “figure-of-eight” polar response will be uniform with respect to frequency.



While many other polar patterns are available from condenser microphones, and even some ribbons, it is this bidirectional pickup that brought the classic RCA-44s early fame and kept them in the forefront of the recording, broadcast, and motion picture industries from their introduction in the 1930s until today.

Since the early 1980s, Audio Engineering Associates has been proud to spearhead the reintroduction of these venerable classics to the industry, and to continue their tradition with new and improved models. Visit www.ribbonmics.com for a full list of all of the models and accessories available.

Appendix 2

Evolution of an Icon

1932 RCA-44A to the 2008 AEA A-440

The oldest piece of pro audio equipment still in regular use is the RCA 44. A revolutionary microphone design, it became the standard of reference for live sound, broadcast, film sound, and recording. It was developed when audio tests were difficult and critical listening was crucial to the process. More than 70 years later, the 44B and BXs are still first rank microphones used daily in music, voice, broadcast and cinema applications.

Dr. Harry Olson is credited as the inventor of the ribbon microphone. He adapted the concept of the ribbon loudspeaker, invented in 1924 by Erwin Gerlach, by reversing the transduction process. He realized one could use a conductive ribbon lightly suspended in a transverse magnetic field, as either a speaker or a microphone. That insight led him to develop of the first high-performance directional microphone in the world, the bi-directional 44A.

The 1932 RCA model 44A was Olson's first commercial success. "Two major characteristics of this type of microphone are particularly attractive from the standpoint of high fidelity sound reproduction, namely a uniform response frequency characteristic over the entire audio frequency range and a uniform directivity pattern over the entire audio frequency range. The ribbon-type velocity microphone was the first wide-frequency-range and high-quality microphone which exhibited a uniform directivity pattern over the entire audio frequency range." (Olson, Journal of the Audio Engineering Society, June 1970)

The rapid advancement of permanent magnet technology in the 1930s had freed Olson's ribbon microphones from the constraints of using an electromagnet. The 44 had an accurate full-bandwidth figure-eight pattern, a transparent wide-range sound, excellent dynamics, required no external power, and was immune to humidity. These characteristics made the audio engineer's job much easier, and set a standard to which others aspired.

The 44A was soon joined by the 77A, the first cardioid microphone. The 44A was replaced in 1936 by the 44B which had more output and a gorgeous black and silver Art Deco case. The 1938 BX revision kept the 44B's high-output, double Alnico magnet design, but had a less reflective umber finish suitable for the newly emerging medium of television. The 44BX remained in production until the mid 1950s. In the mid 1970s RCA ceased all microphone production. However both the 44B and BX and its cousins the RCA-77D and DX remain in continuous use in recording studios and on scoring stages.

As magnetic tape became the dominant media for recording, ribbon microphones fell out of favor. Magnetic recording with its greater linearity and dynamic range solved many disc and optical recording problems and pioneers such as Les Paul and the Beatles became quite creative with multi-generational magnetic recording. However there was always a slight loss of highs from generation to generation. Large capsule condenser microphones helped resolve this problem as they have a number of high-Q resonances in the 8 to 12 K Hz range. The treble 'tizz' this imparts became popular, because after a couple of transfers these recordings sounded just right on the radio or juke box.

With the advent of digital recording, ribbon microphones made a major comeback. Their ability to record fast transients accurately without adding upper-range resonances became a positive attribute, as high-frequency transfer loss was no longer a problem. Users have also become more familiar with the usefulness of a ribbon microphone's native figure-eight polar pattern and proximity effect bass tip-up. With fundamental tunings as low as 16 Hz the 44 is the king of bass. The 44 is flat down to 20 Hz from a distance, and if used closer than six feet starts to have bass tip-up. No wonder announcers love them.

AEA began restoring and repairing RCA ribbon microphones soon after RCA ceased production and service. In the early 1980s AEA also began servicing and importing STC/Coles 4038 studio ribbon microphones. Over the next two decades AEA started making replacement RCA parts, and finally developed a complete set of external parts for the 44 based on the classic RCA 44BX built in Camden, NJ. During this period appreciation for the 44's sonic character continued to grow. Antique and radio collectors also admired them which decreased their availability and increased their price.

Mentored by Jon Sank, one of the last engineers who worked for the RCA microphone division, Wes Dooley (AEA's owner and chief engineer) began work on reproducing the interior parts. The 44 had been produced in Camden, New Jersey; Hollywood, California; London, England; and Australia. While repairing and analyzing these different versions, Wes and his team correlated which design elements had the most "pleasing" sound quality for their owners. The AEA R-44C incorporated those design elements.

The primary difference between the AEA R-44C and the RCA-44B/BX is in the magnets. The RCA-44B/BX used high-output Alnico magnets, the best available at the time. By the 1990s, neodymium had replaced Alnico as the best material for this purpose, so it was used in the AES R44C. True to their origins in providing repair services for these classic microphones, all of the assemblies of the AEA microphone are directly interchangeable with the original RCA.

AEA's service department was already fortunate to be using New-Old-Stock (NOS) ribbon material from the 1970s that had been made for RCA. Once a custom microphone output transformer was developed that matched the original RCA sonics, the culmination of this work was the introduction of the AEA model R44C at the 1998 AES Convention in San Francisco. AEA has continued to make use of modern technology to create new versions so as to bring this classic microphone closer to Olson's ideal: the best microphone possible for music and voice work.

The AEA R-44CNE was released in 2001 to celebrate the 100th anniversary of the NAMM (National Association of Music Merchants, now named the International Music Products Association). As with RCA 44s produced in England and Australia, the R44CNE has a simplified shell and cushion-mount assembly. The internal parts are the same as the 'museum quality' R44C series. By simplifying the shell and cushion-mount this version sells at a lower price than the model R44C, the 1936 museum replica.

AEA developed the 'X' motor option using higher energy magnets to increase the output of the microphone by 6 dB. This version was developed at the request of scoring mixers who needed a lower noise floor, and did not need to match exactly the sound of original RCA 44s. This allowed "Lord of the Rings" scoring engineer John Kurlander to mix his AEA R44 string pair almost as high in the mix as his main Neumann M-50 tube microphones on the Decca Tree.

Detail changes continue to be made to the AEA 44 series as AEA gains more experience. The most dramatic technical revision was changing the internal wiring from the top of the ribbon to the transformer input leads. Examination of the RCA 44 production from England revealed that their wiring scheme reduced hum sensitivity by 20 dB without altering the sound. This wiring was immediately adopted for all R44 microphones. More recently the yoke material casting on the R44C was changed from zinc to bronze. The original RCA zinc yokes were found to fail when the plating wears through and the zinc is exposed to moisture. More recently the R44C cushion-mount cable-clamps were changed from cast zinc to machined brass.

Recalling Olson's prediction that a well designed ribbon microphone might have the lowest self-noise of any microphone type, AEA next focused its attention on lowering the noise and extending the linearity of the ribbon microphone / microphone preamplifier interface. The 2005 AEA model TRP ribbon microphone preamplifier was designed specifically to deliver high gain while reducing noise and increasing linearity. This JFET design has a low noise floor, is DC coupled for wide bandwidth, and has a no load, ultra-high input impedance design that delivers exceptional frequency response linearity and better signal to noise with ribbon microphones.

Following on the widespread acclaim for the TRP, the next logical step was to incorporate similar circuitry inside the microphone itself. The AEA model A-440 debuted at the NAB Show in April 2008. Its internal phantom-powered JFET buffer amplifier is combined with a new, higher-ratio transformer to provide 12 dB more gain than the 'X' motor alone. The equivalent acoustic self-noise of the combination is 9 dB (A) or less – making it among the quietest microphones made. Although the acoustic frequency response of an A440 is the same as an R44CX, the sonic character is different. This character is often described as “warmer” or “more tube-like.” and the bass is reported as having more weight.

Placing a buffer amplifier inside the A440 radically reduces the distance between the ribbon step-up transformer and the first electronics stage. This decreases mic-line noise interference. It also buffers the microphone preamp from possible low frequency EQ effects as a ribbon's output impedance rises at resonance. The A440's audio-band output impedance is a constant 92 ohms for flatter low frequency response when driving typical microphone preamps.

The trade off with such an active studio ribbon designs is a reduction of the 165 dB SPL capabilities of the AEA's passive R series ribbon microphones. While microphone positions that exceed 135 dB SPL are rare two examples are extremely close horn and percussion microphone positions pickup . Under such circumstances, moving the microphone back three to six inches can solve the problem.

The A440 has the ability to drive a 1,000 ohm load at SPLs up to 135 dB and a high sensitivity of -33.5 dBV at 94 dB SPL (30 mV/Pa). The A440 matches conventional microphone preamplifiers quite well. The A440 draws 7 mA of P48 phantom power. This amount of current allows it to achieve a noise floor of 9 dB (A) or less with a headroom limit of 135 dB SPL.

Knowledgeable engineers never stopped using the 44. In the mid 1960s remote recording pioneer Wally Heider always used RCA ribbons on big bands and horn sections. Capitol Records Studios maintains a large collection of 44s and has used them continuously on projects since the 1940s. Performers such as Bing Crosby owned their own personal 44s. Young Frank Sinatra's use of a 44 in live performances was brilliant. He understood how to work the 44 to change his sound dynamically during a song and increase its dramatic impact.

Contemporary scoring engineers also consistently use the 44. Scoring engineer Shawn Murphy typically records his string solos with a Blumlien pair of ribbons forward, and a pair Schoeps MK2H omnis further back.. Itzhak Perlman's solos in "Memoirs of a Geshia" (2005) were recorded using AEA R44Cs as the Blumlein pair. In 2005 EmmyLou Harris won a best female country vocal Grammy with "The Connection" which Nashville producer/Engineer Brian Ahern recorded using a single an 'X' motor AEA R44. In 2008 The Turtle Island String Quartet album "A Love Supreme" won a Grammy for Best Classical Crossover album. All the closer microphones were AEA ribbons, with the electric cello on an AEA R44CNE. http://www.wesdooley.com/pdf/PR_Turtle_Island_String_Quartet2.doc

Is the A440 the best 44 incarnation ever? Time will tell. The A440 is a very useful development of the 44. Engineers who have considerable experience with both RCA and AEA 44s like it very much. On Hollywood scoring stages and at world class studio facilities such as Blackbird in Nashville it is being used on major projects. The 44 is an astonishingly good microphone which is why AEA started reproducing it in 1998. It has been evolving for over 75 years, and has adapted amazingly well to contemporary studio needs. There is likely a lot more that will happen in this ongoing story, and AEA is honored to be part of it. Your ears get to decide.

Appendix 3

Bidirectional Microphones for Stereo and Surround Sound

For working in stereo, two bidirectional microphones, oriented at 90 degrees with respect to each other, create the classic crossed bidirectional pair. This also is commonly called a Blumlein pair, in recognition of Alan Blumlein who first proposed this technique in his seminal patent of 1934. This technique provides what many engineers consider the most natural sounding stereophonic image of any microphone configuration because it provides an extremely even spread with precise and accurate localization within the stereo stage.

As with a single bidirectional microphone, a Blumlein pair can be worked from opposite sides with equal effect. This allows multiple actors or musicians to group in the front and back quadrants of the microphone pair for a full stereophonic performance. Notice, as shown in Figure-9, that the stereo channels in the back quadrant are reversed with respect to the front, and this must be kept in mind when arranging the stereo stage perspective. It also is important to realize that the two side quadrants are out of phase with each other, so any direct sound should be avoided here, lest it become vague and difficult to localize; under extreme conditions, it can cancel entirely when summed to mono.

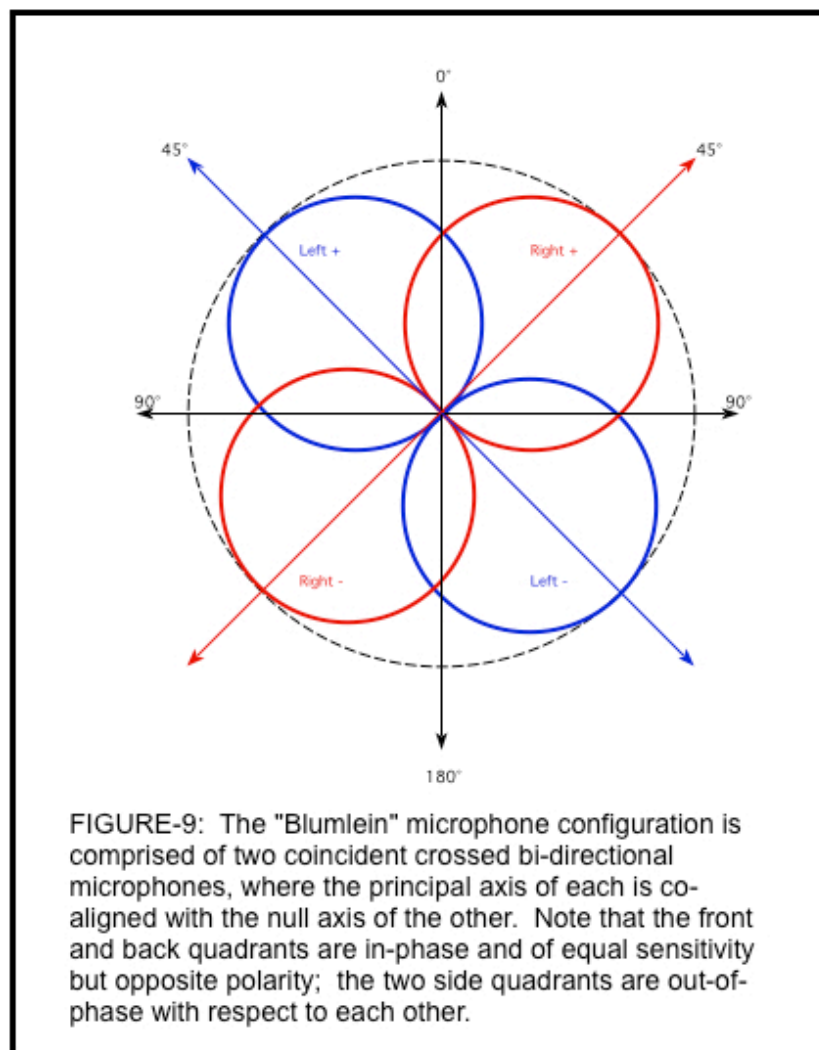

There is another important stereophonic microphone configuration that Blumlein defined in his 1934 patent, the mid/side technique, and this too has the bidirectional microphone at its core. In fact, it is the bidirectional component that provides all of the directional information in this stereophonic pickup technique. The mid/side system employs two vertically coincident microphones: a forward-facing (mid) microphone and a laterally oriented bidirectional (side) microphone.

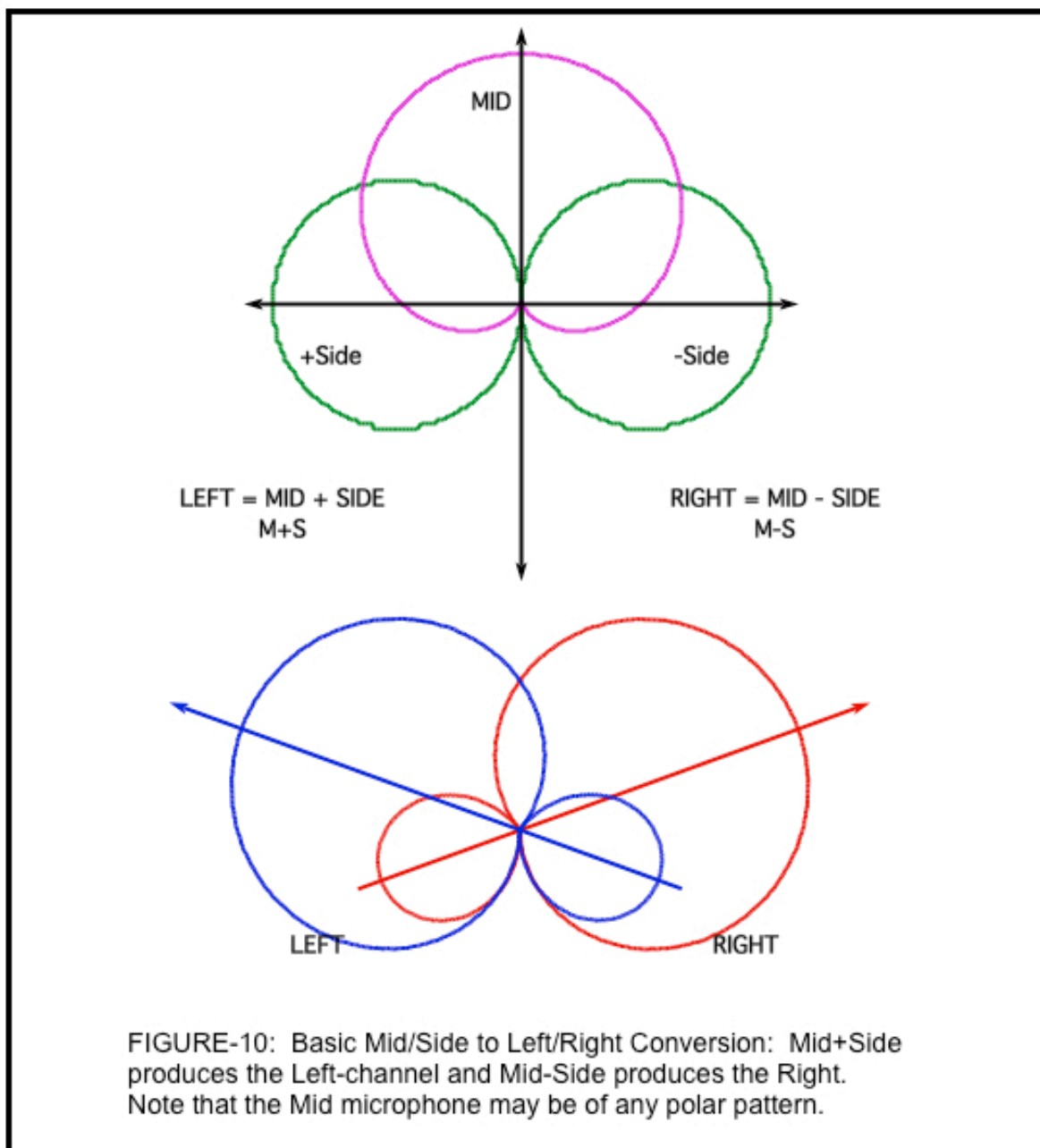

By combining these component signals via a sum-and-difference matrix, the left channel traditionally is the mid + side signal and the right is the mid - side. (Although a cardioid is shown as the mid microphone in Figure-10, any polar pattern can be used.) Also, the ratio of mid-to-side also can be varied in the matrix to adjust the width of the resulting stereophonic image. Varying both the polar pattern of the mid microphone and the mid-to-side ratio can produce a rich variety of stereophonic perspectives.

By using the mid/side technique, an extremely natural and versatile stereophonic image can be produced. Not only can this rival or surpass any other conventional stereo pickup, it also is the only one that is capable of providing a virtually infinite variety of stereo perspectives while remaining fully mono compatible.

Carrying this principle even further, by employing bidirectional patterns oriented along the three cardinal axes — lateral, fore/aft, and vertical — and then matrixing these with an omnidirectional pickup, the complete spherical sound field can be described. This is the essence of the Sound-Field microphone system, developed by Michael Gerzon in the 1970s.

For a detailed treatise on stereophonic and surround-sound recording and reproduction techniques, refer to *The New Stereo Soundbook*, Third Edition, by Ron Streicher and F. Alton Everest. Available exclusively from AEA and www.stereosoundbook.com.

Other Products by Audio Engineering Associates:

RPQ - Active Studio Ribbon Pre with Curve Shaping

AEA/Fred Forsell collaboration preamp with no phantom power and 83dB of clean gain

TRP - The Ribbon Pre

AEA/Fred Forsell collaboration preamp with no phantom power and 83dB of clean gain

RCA Working Reproduction Microphones and replacement parts

AEA R44C and CNE Microphone - Tribute to the classic RCA 44B using NOS ribbons

AEA R44CX Microphone - 6db more output for critical digital recordings

RCA44 and RCA77 microphones - Spare parts and prop shells

AEA Ribbon Microphones

AEA R92 Microphone - Large-ribbon optimized for guitar and other close-micing situations

AEA R88 Microphone - Large-ribbon coincident pair in a sleek black "stealth" package

AEA R84 Microphone - That big ribbon sound in a smaller more affordable package

AEA R840 Microphone - The powered version of the R84

Modular Microphone Positioners

SMT - Stereo Microphone Template for Blumlein and ORTF spacing

SMP-17, 1M and 1.25M - Stereo bars in three lengths for the ultimate in positioning flexibility

Decca and Mini-Decca Trees - For microphone arrays including recording for multichannel

Modular Studio Microphone Stands and Booms

Flightweight Stands

Medium-Duty Vertical Stands and Booms

Heavy-Duty Stands and Booms

Crank-up Stands

Since 1983 we've been the US agent for Coles Electroacoustics, manufacturers of the 4038 studio ribbon microphone and the 4104B, "lip" mic for voice-over work in high noise environments. We sell and service Coles microphones and genuine Coles parts.

In North America we represent CB Electronics, a leading worldwide supplier of machine control equipment to the sound-for-picture industry. Their products specialize in professional control of and translation between bi-phase, 9-pin serial and time code machines. Their SR line provides low cost multiple machine remote controls for RS-422, Sony, and Tascam DA88 protocol machines. The new P2DVD Interface may be a RS422 controlled Master with most RS422 synchronisers and Console automation systems.

Our Audio Test Department buys, sells, trades, and rents new and used audio test gear. Audio Precision, B&K, Hewlett Packard, Galaxy, Goldline, Neutrik, and Amber are among the lines we maintain in stock for audio measurements of Level, Polarity, Phase, THD and IMD, W&F, SPL, and Real-Time Analyzers.

Audio Engineering Associates

1029 N. Allen Ave., Pasadena, CA 91104, USA

Phone: (626) 798-9128 Fax: (626) 798-2378

Visit us on the web at www.ribbonmics.com